



**WEATHERBY®**

---

**MARK V®**  
**RIFLES**

**OWNER'S MANUAL**

---

# INTRODUCTION

---

Thank you for buying a Weatherby® firearm and welcome to the family. We realize that you had many products to choose from and hope you feel as we do that you purchased the finest quality production firearm on the market today.

When my late grandfather started this company in 1945, it was as a means to turn his revolutionary vision of rifle design and cartridge performance into practical realities.

At the time, I'm sure he had little idea that Weatherby® would come to be one of the most respected and revered brands in the firearms industry. We appreciate this level of respect and you have our assurance it will not be taken for granted.

This Owner's Manual is designed to assist you in learning how to safely use and care for your Weatherby® Vanguard® rifle. Please read the entire contents thoroughly and carefully follow all instructions and safety warnings.

In closing, let me assure you that we are committed to the hunter, shooter and sportsman; and delivering the uncompromising craftsmanship, performance and value that you require in all that we do.

Good Shooting!

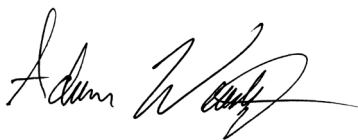
A handwritten signature in black ink, appearing to read "Adam Weatherby", with a stylized flourish at the end.

Adam Weatherby

# - SAFETY -

## FIRST AND FOREMOST

**FIREARMS ARE DANGEROUS WEAPONS, WHICH CAN CAUSE SERIOUS INJURY OR DEATH. WHEN USING ANY FIREARM, SAFETY MUST BE YOUR FIRST AND CONSTANT CONCERN.**

**FAILURE TO FOLLOW ANY OF THE WARNINGS AND INSTRUCTIONS IN THIS OWNER'S MANUAL COULD RESULT IN SERIOUS INJURY OR DEATH.**

**READ AND UNDERSTAND THE FOLLOWING SAFETY RULES:**

**KNOW YOUR FIREARM.** Before assembling or using your Weatherby® Mark V® rifle, be sure to read and understand all instructions and safety warnings contained in this Owner's Manual in order to learn how to use the firearm safely and correctly.

**ALWAYS TREAT YOUR FIREARM AS IF IT WERE LOADED.** Use the manual safety lever as outlined in this manual. Never move the safety to the "FIRE" position until YOU are ready to fire.

**ALWAYS KEEP THE MUZZLE POINTED IN A SAFE DIRECTION.** The safe direction may be "up" on some occasions, and "down" on others. Never point the muzzle toward anything not intended as a target.

**USE ONLY THE CORRECT AMMUNITION FOR YOUR FIREARM.** Be sure to use only the correct ammunition for your Weatherby® Mark V® rifle as stamped on the side of the barrel.

**ALWAYS UNLOAD YOUR FIREARM WHEN NOT SHOOTING.** Never transport or store a loaded firearm in a vehicle or building. Unload your firearm before climbing a tree, fence or other obstruction, or when entering a slippery area.

**MAINTAIN YOUR FIREARM.** Keep the barrel clean and free of obstructions. Clean your firearm regularly and have it inspected periodically to make sure it is mechanically correct and functioning properly. Worn or damaged parts can be dangerous.

**DO NOT MAKE UNAUTHORIZED ADJUSTMENTS.** Never make alterations to your firearm. Use only Weatherby® parts. Do not make any changes to the shape or size of the sear or other parts. Repair should be performed by a Weatherby® Authorized Service Center.

**STORE YOUR FIREARM AND AMMUNITION SEPARATELY, WELL BEYOND THE REACH OF CHILDREN.** Always take appropriate measures to ensure your firearm is not accessible to children or others who are untrained or inexperienced in its safe handling.

**MAKE YOURSELF SAFE.** Always wear shooting glasses and use ear protection when shooting or attending shooting events. Never drink alcoholic beverages before or during shooting.

**REMEMBER - FIREARMS SAFETY DEPENDS ON YOU!!**

# TABLE OF CONTENTS

• Introduction	Page 2
• Safety-First and Foremost	Page 3
• Table of Contents	Page 4
• General Overview	Page 5
• Manual Safety Operation	Page 6
• Ammunition	Page 6-7
• Operating Instructions	Page 7
• Inserting Bolt Assembly into Receiver	Page 7
• Removing the Bolt Assembly from Receiver	Page 8
• Checking for and Clearing Bore Obstructions	Page 8
• To Check the Barrel for Obstructions	Page 8
• If There is an Obstruction	Page 8
• To Load the Magazine	Page 9
• To Feed a Cartridge from the Magazine into the Chamber	Page 9
• Firing the Rifle	Page 10
• Unloading the Rifle	Page 10
• Disassembly Instructions	Page 11
• Disassembly of the Mark V® Rifle	Page 11
• Disassembly of the Bolt Assembly	Page 11-12
Cleaning of the Bolt Assembly	Page 12
• Assembly of Bolt After Cleaning	Page 12-13
Cleaning Your Weatherby® Mark V® Rifle	Page 13
• Cleaning the Bore	Page 13-14
• Cleaning the Outside of the Barrel and Receiver	Page 14
• Cleaning Muzzle Brakes	Page 14
• Cleaning the Receiver	Page 15
• Cleaning the Magazine	Page 15
• Cleaning the Trigger Guard Assembly	Page 15
• Cleaning/Lubricating the Trigger Assembly	Page 15
• Cleaning the Stock	Page 15
• Rust Prevention and Repair	Page 16
• Assembly of Weatherby® Mark V® Rifle	Page 16
• Assembly of Barrel and Receiver to Stock	Page 16
• Trigger Assembly Adjustment	Page 16-17
• Storing Your Rifle	Page 17-18
• Suggestions for Getting Top Performance from Your Weatherby® Mark V® Rifle	Page 18
• Exploded View Diagram	Page 19
• Part List	Page 20
• Weatherby Service Policy	Page 21
• Ten Commandments of Firearms Safety	Page 21-22
• Exercise Extreme Caution	Page 22

# WEATHERBY® MARK V® RIFLE GENERAL OVERVIEW

The Weatherby® Mark V® is a bolt action rifle primarily used for hunting and target shooting.

With proper care as outlined in this manual, your Mark V® rifle should give you many years of dependable use and shooting pleasure.

The picture below shows the main parts of the Mark V® rifle. Please refer to it when reading this manual, as it will help you understand the terminology.

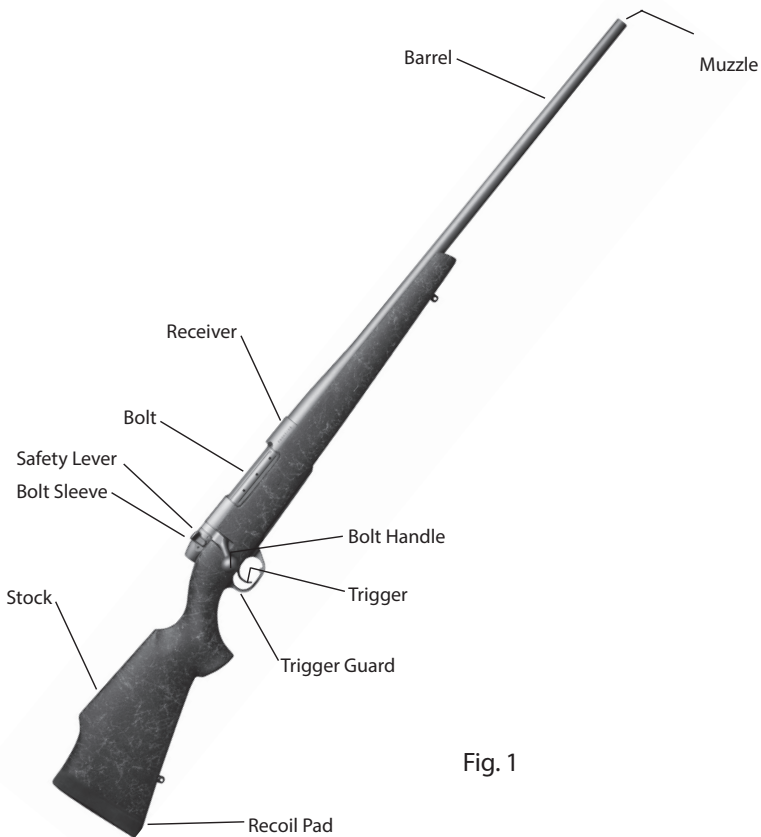

Fig. 1

# MANUAL SAFETY OPERATION

The manual safety on the Mark V® rifle is a lever-type safety located on the side of the bolt sleeve immediately behind the bolt handle. When in proper condition and correctly engaged in the "SAFE" position, the manual safety blocks the firing pin and prevents accidental discharge under normal usage.

## WARNING

Never depend on any mechanical safety mechanism or device to prevent the dangers of careless handling or pointing a firearm in an unsafe direction. Unsafe handling can result in serious injury or death.

When manipulating the manual safety, keep all fingers outside the trigger guard. The rifle will fire if the trigger is pulled when the safety is not in the "SAFE" position.

The safety should always be in the "SAFE" position except when the rifle is intended to be fired.

Never pull the trigger when the safety is in the "Safe" position.

The manual safety can only be moved between the "SAFE" and "OFF SAFE" positions when the rifle is cocked.

To engage the manual safety, use your thumb to rotate the safety lever rearward until the safety lever is horizontal with the barrel and covering the red dot. Figure 2 depicts the safety in the "On Safe" position on a right hand action.

To disengage the safety, use your thumb to rotate the the safety forward from the horizontal "On Safe" position until the safety lever is perpendicular to the barrel, and the red dot is exposed. Figure 3 depicts the safety lever in the "Off Safe" position on a right hand action.



Fig. 2



Fig. 3

# AMMUNITION

Weatherby® Mark V® rifles are chambered for numerous calibers and cartridges ranging from .223 Remington to .460 WBY MAG (Weatherby® Magnum), for which factory-loaded ammunition manufactured in accordance with U.S. industry standards is commercially available.

 **WARNING**

**Use of incorrect or overloaded ammunition can result in death or serious injury and damage to your firearm due to excessive pressure. Even the strongest firearm can be “blown up” by excessive pressure. Use only factory-loaded ammunition of the correct caliber as marked on the rifle’s barrel.**

Exercise care to assure that you are using only the correct ammunition for your rifle. Always make certain that the caliber and cartridge indicated on the factory loaded cartridge headstamp matches the caliber and cartridge type marked on the barrel of your rifle. Never store cartridges of mixed calibers in a common container or in your pockets. Examine every cartridge you put into your rifle.

**AMMUNITION NOTICE**

NEVER STORE CARTRIDGES OF MIXED CALIBERS IN A COMMON CONTAINER OR IN YOUR POCKETS. EXAMINE EVERY CARTRIDGE YOU PUT INTO YOUR RIFLE. WEATHERBY, INC. SPECIFICALLY DISCLAIMS RESPONSIBILITY FOR ANY INJURY OR DAMAGE WHATSOEVER OCCURRING IN CONNECTION WITH, OR AS A RESULT OF, THE USE OF FAULTY, OR NON-STANDARD, OR "REMANUFACTURED" OR HAND-LOADED OR RELOADED AMMUNITION, OR OF AMMUNITION OTHER THAN FOR WHICH THE FIREARM WAS ORIGINALLY CHAMBERED.

 **WARNING**

**DISCHARGING FIREARMS IN POORLY VENTILATED AREAS, CLEANING FIREARMS, OR HANDLING AMMUNITION MAY RESULT IN EXPOSURE TO LEAD OR OTHER SUBSTANCES KNOWN TO CAUSE BIRTH DEFECTS, REPRODUCTIVE HARM AND OTHER SERIOUS PHYSICAL INJURY. HAVE ADEQUATE VENTILATION AT ALL TIMES. WASH HANDS THOROUGHLY AFTER EXPOSURE.**

## OPERATING INSTRUCTIONS

### INSERTING BOLT ASSEMBLY INTO RECEIVER

**Keeping the muzzle of the rifle pointed in a safe direction and your fingers out of the trigger guard and away from the trigger (except as instructed below):**

1. Inspect the rifle and remove any ammunition present in the chamber or magazine (*refer to items 3 & 4 of Unloading the Rifle, page 7*).
2. Fit the front end of the bolt assembly into the rear of the receiver.
3. Pull the trigger rearward as far as possible.
4. Slide the bolt assembly forward into the receiver about three inches and release the trigger.
5. As the bolt assembly moves forward in the receiver, slightly rotate the bolt assembly right or left until the bolt stop engages the bolt stop groove on the underside of the bolt.
6. Once the bolt stop is engaged the bolt assembly is ready to be pushed forward to the fully closed position.

## REMOVING THE BOLT ASSEMBLY FROM RECEIVER

**Keeping the muzzle of the rifle pointed in a safe direction, and your fingers out of the trigger guard and away from the trigger (except as instructed below):**

1. Move the safety lever to the "Off Safe" position (*refer to Manual Safety Operation, page 6*).
2. Open the bolt by rotating the bolt handle upward until the bolt rotation stops.
3. Move the bolt to the rear until the bolt hits against the bolt stop.
4. Inspect the rifle to ensure no rounds are in the magazine or chamber (*refer to items 3 & 4 of Unloading the Rifle, page 10*).
5. Pull the trigger rearward as far as possible
6. Move the bolt straight rearward until the bolt clears the receiver

## CHECKING FOR AND CLEARING BORE OBSTRUCTIONS

The barrel of your rifle should always be checked for obstructions before assembly, before loading and immediately following any occurrence in the field which might result in mud, dirt or other debris entering the bore.



**Never attempt to check for or clear a bore obstruction by loading a cartridge into the chamber of the barrel and firing! If there is a bore obstruction this will cause excessive pressures which may result in death or serious injury and damage to your rifle.**

## TO CHECK THE BARREL FOR OBSTRUCTIONS

**Keeping the muzzle of the rifle pointed in a safe direction, and your fingers out of the trigger guard and away from the trigger at all times:**

1. Move the manual safety to the "OFF SAFE" position (*refer to Manual Safety Operation, page 6*).
2. Unload the rifle (*refer to Unloading the Rifle, page 10*).
3. Remove the bolt (*refer to Removing the Bolt Assembly from the Receiver, page 8*).
4. Visually check the bore for obstructions by looking through the barrel from the breech end through the muzzle.

## IF THERE IS AN OBSTRUCTION

1. Push a rifle bore cleaning tool through the bore from the breech end until the end of tool exits the muzzle.
2. If the obstruction cannot be easily cleared, contact our Weatherby® Service Department.



## LOADING THE RIFLE

### TO LOAD THE MAGAZINE

**Keeping the muzzle of the rifle pointed in a safe direction, and your fingers out of the trigger guard and away from the trigger at all times:**

1. Move the manual safety lever to the "OFF SAFE" position (*refer to Manual Safety Operation, page 6*).
2. Open the bolt by lifting the bolt handle until it stops. Pull the bolt to the rear until it stops.
3. Visually check to make sure no cartridge is in the chamber.
4. Insert desired number of cartridges of the proper caliber and cartridge type (*refer to Ammunition, page 6 & 7*) into the magazine by pressing them individually into the top of the magazine box with the bullets pointed toward the barrel.
5. Use your thumb or fingers to press the top cartridge down as you push the bolt forward so the bolt does not strip the cartridge from the magazine and load it into the chamber.
6. Immediately move the safety lever to the "On Safe" position (*refer to Manual Safety Operation, page 6*)

### TO FEED A CARTRIDGE FROM THE MAGAZINE INTO THE CHAMBER

**Keeping the muzzle of the rifle pointed in a safe direction and your fingers out of the trigger guard and away from the trigger at all times:**

1. Visually check the manual safety to make sure it is in the "OFF SAFE" position (*refer to Manual Safety Operation, page 6*).
2. Open the bolt by lifting the bolt handle until it stops and pulling the bolt to the rear until it stops.
3. Close the bolt by pushing the bolt handle forward. As the bolt moves forward it will strip a round from the magazine and feed it into the chamber.
4. With the bolt fully forward rotate the bolt handle down until it stops. The rifle is now ready to fire. Keep your fingers out of the trigger guard and away from the trigger until you are ready to fire the rifle.
5. Immediately rotate the safety lever rearward to the "On Safe" position (*refer to Manual Safety Operation, page 6*).

#### **WARNING**

**If the manual safety is not in one of the "SAFE" position, the rifle is ready to fire. Do not touch the trigger until YOU are ready to fire, as an inadvertent trigger pull could result in serious injury or death.**

#### **CAUTION**

**Always wear ear and eye protection to guard against hearing loss and to prevent damage to your eyes from flying particles**

## FIRING THE RIFLE

### **Pulling the trigger fires the rifle when a cartridge is in the chamber.**

1. With a cartridge of the proper caliber and type in the chamber of the barrel, and keeping the muzzle of the rifle pointed in a safe direction and your fingers out of the trigger guard and away from the trigger, rotate the manual safety lever to the "Off Safe" position (*refer to Manual Safety Operation, page 6*).
2. Hold the recoil pad snugly to your shoulder and carefully point the muzzle of the rifle at your intended target, using properly installed sights or riflescope to aim.
3. Squeeze (pull) the trigger with steadily increasing pressure until the rifle fires.



**Do not touch the trigger until you are actually ready to fire the rifle, or an unintended discharge may occur, possibly resulting in death or injury to a bystander, or damage to an unintended target.**

**NOTICE: Never use a fixed or immovable rest or place sand bags directly behind the pistol grip when shooting your Mark V® rifle . On firing, recoil drives the rifle back with great force, transferring recoil energy to all points of contact, which may result in unreparable damage to the pistol grip or stock. Weatherby, Inc. will not be responsible for such damage.**

## UNLOADING THE RIFLE

*ALWAYS UNLOAD YOUR RIFLE IMMEDIATELY AFTER YOU FINISH SHOOTING.*

### **Keeping the muzzle of the rifle pointed in a safe direction and your fingers out of the trigger guard and away from the trigger at all times:**

1. Move the manual safety lever to the "OFF SAFE" position (*refer to Manual Safety Operation, page 6*).
2. To remove a cartridge from the chamber, open the bolt by lifting the bolt handle until it stops and pulling the bolt to the rear until the bolt stops against the bolt stop. The cartridge will be ejected from the receiver.
3. Visually and manually check to make certain that the bolt has extracted any live round or fired cartridge case from the chamber. If a live round or fired cartridge case remains in the chamber, remove the bolt, (*refer to Removing The Bolt Assembly From The Receiver, page 8*) and immediately take the rifle to a Weatherby® service center or a qualified gunsmith, keeping the bolt out of the rifle at all times.
4. To unload the magazine, open the floor plate by depressing the floor plate latch (*refer to Fig. 4*). The floor plate will swing out, allowing the cartridges to drop free. Do not allow the cartridges to fall to the ground as they may be damaged or become dirty making loading and chambering more difficult. Subsequent loading of a damaged or dirty cartridge may cause a live round to become jammed in the chamber of the firearm resulting in an unsafe condition.
5. Visually and manually reconfirm that there are no cartridges remaining in the magazine or chamber.
6. Reposition the magazine follower inside the magazine box and close the floorplate.

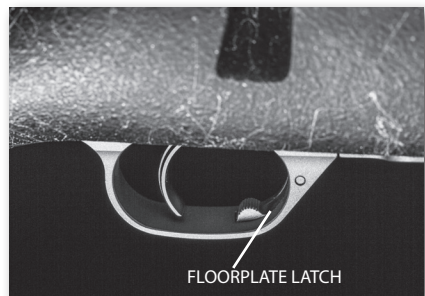

Fig. 4



**IF THE BOLT IS PUSHED ALL THE WAY FORWARD AND A CARTRIDGE IS IN THE MAGAZINE, THAT CARTRIDGE WILL BE CHAMBERED AND THE RIFLE CAN BE FIRED. THEREFORE, ALWAYS DOUBLE CHECK THE MAGAZINE AND CHAMBER.**

## DISASSEMBLY INSTRUCTIONS

### DISASSEMBLY OF THE MARK V® RIFLE

Before attempting to disassemble your MARK V® rifle, study the exploded view diagram on page 19 of this Owner's Manual to familiarize yourself with the general appearance and position of each part.

1. Unload the rifle. (refer to *Unloading the Rifle*, page 10)
2. Move the safety lever to the "Off Safe" position (refer to *Manual Safety Operation*, page 6).
3. Raise the bolt handle and draw the bolt all the way to the rear.

**4. VISUALLY CHECK THE CHAMBER AND THE MAGAZINE TO BE CERTAIN THERE ARE NO CARTRIDGES IN THE RIFLE**

5. Remove the bolt assembly (refer to *Removing the Bolt Assembly from the Receiver*, page 8).
6. Remove the trigger guard assembly and stock.
  - a. Press the floorplate latch (refer to Fig. 4) to open the floorplate.
  - b. With a screwdriver of the proper size, remove the front and rear trigger guard screws.
  - c. Remove the trigger guard assembly from the stock.
  - d. Remove the stock.

### DISASSEMBLY OF THE BOLT ASSEMBLY

1. Remove the bolt. (refer to *Removing the Bolt Assembly from Receiver*, page 8)
2. Using a square-faced object, push the cocking piece from its post-firing position (refer to Fig. 5) to the rear, and rotate it onto its engaging shoulder in the bolt sleeve (refer to Fig. 6)."



Fig. 5

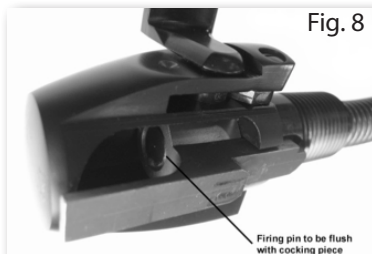
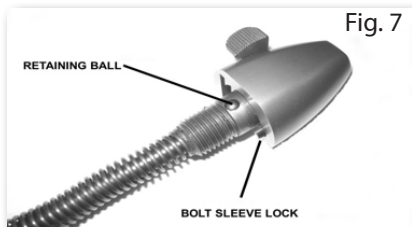

Fig. 6

3. Disengage the bolt sleeve lock (refer to Fig. 7) by pushing it in with a blunt object or finger and unscrew the bolt a few turns until the firing pin retaining ball is completely exposed (refer to Fig. 7).
4. Remove the retaining ball and unscrew the bolt body completely from the bolt sleeve.

## NOTICE

**Further disassembly is not recommended and could result in damage to your rifle. If further disassembly is required, contact a Weatherby Authorized Service Center or qualified gunsmith.**



### CLEANING OF THE BOLT ASSEMBLY

1. Clean all parts with a gun cleaning solvent and dry with a clean cloth. Use of a small brush will help in cleaning recesses of the bolt sleeve and firing pin spring.
2. With a clean cloth or patch, apply a light coat of gun oil to all accessible surfaces of the bolt assembly parts, being careful to remove any excess oil.

## ⚠ CAUTION

**Failure to strictly adhere to the disassembly and assembly instructions contained herein may result in damage to your rifle and/or cause personal injury or death.**

### ASSEMBLY OF BOLT AFTER CLEANING

1. Hold the bolt sleeve horizontally with the retaining ball hole "UP" (refer to Fig. 7).
2. While firmly holding the cocking piece on its engaging shoulder (refer to Fig. 6), rotate the firing pin clockwise until one of the firing pin grooves is directly under the retaining ball hole, with the end of the firing pin flush with the rear surface of the cocking piece (refer to Fig. 8).
3. Examine the bolt sleeve assembly to assure that the rear end of the firing pin is flush with the rear end of the cocking piece (refer to Fig. 8).
4. Insert the retaining ball into the retaining ball hole in the bolt sleeve (refer to Fig. 7).
5. Screw the bolt body onto the bolt sleeve until it is stopped by the bolt sleeve lock hitting the bolt.
6. Push in the bolt sleeve lock (refer to Fig. 7) with a blunt object or finger and continue screwing the bolt body onto the bolt sleeve until the bolt sleeve stops against the bolt body.



8. Rotate the cocking piece off the engaging shoulder of the bolt sleeve allowing the firing pin assembly to move forward (refer to Fig. 5 & 6).

9. Assemble bolt to receiver (refer to *Inserting Bolt Assembly into Receiver*, page 7).

Any firearm requires regular cleaning and periodic maintenance. To ensure safe and reliable functioning of your Weatherby Mark V® rifle, it is very important that you clean it immediately after each use, and periodically during extended storage periods, to remove powder residue, dirt, dust and excess lubricant, and to prevent rust. During cleaning, inspect components to determine whether they are in proper working order.

## CLEANING YOUR WEATHERBY® MARK V® RIFLE

A basic cleaning kit consists of proper-sized cleaning rod, bore brush(es) and patches, gun cleaning solvent, gun lubricant, and lint-free cloth. The cleaning rod must have a tip with a slot into which patches can be inserted. Additionally, plastic bristle gun cleaning brushes, cotton swabs and pipe cleaners are very handy tools for cleaning away dirt in hard to reach places.

To properly clean your rifle, it must first be disassembled (refer to *Disassembly of the Mark V® Rifle*, page 11), the parts and components cleaned as discussed below, then reassembled (refer to *Assembly of Weatherby® Mark V® Rifle*, page 16).

### NOTICE

**Apply solvents and lubricants properly and sparingly. Do not spray or apply directly on ammunition. Solvents and lubricants may affect the propellant, causing it not to ignite, but the energy from the primer may be sufficient to propel the propellant and bullet into the bore of the barrel, causing an obstruction, and resulting in damage to the rifle and serious injury to the shooter and bystanders upon firing a subsequent cartridge.**

#### CLEANING THE BORE

1. Remove the bolt (refer to *Removing the Bolt Assembly from the Receiver*, page 8).
2. With a bore cleaning brush of the proper size attached to the cleaning rod, apply gun cleaning solvent to the brush.
3. Push the cleaning rod all the way through the bore from the chamber end several times.
4. With a clean patch inserted in the tip attached to the cleaning rod, push the rod all the way through the barrel bore from the chamber end until the cloth emerges from the muzzle. Remove the dirty patch and withdraw the rod.
5. Repeat step 4 as many times as needed until the patch is clean as it emerges from the muzzle.
6. Using a clean patch or lint-free cloth wrapped around the tip of your finger or similarly shaped object, remove all solvent from the muzzle.
7. Insert a patch saturated with gun lubricant into the cleaning rod tip and push it through the bore from the chamber end. Remove the patch and withdraw the rod.
8. Insert a dry, clean patch into the cleaning rod tip and push it through the bore from the chamber end, to remove excess lubricant. Remove the patch and withdraw the rod.

9. Using a clean patch or lint-free cloth wrapped around the tip of your finger or similarly shaped object, apply a light coat of gun lubricant to the muzzle.



**Excess lubrication in the bore or chamber of any firearm may create excessive chamber pressures or a partial bore obstruction, resulting in possible damage to the firearm and serious injury to the shooter and bystanders upon firing. BE SURE ALL EXCESS LUBRICANT HAS BEEN REMOVED.**

#### CLEANING THE OUTSIDE OF THE BARREL AND RECEIVER

1. Using a patch or clean cloth saturated with cleaning solvent, wipe down all accessible surfaces of the barrel and receiver. (A clean tooth brush may be handy for cleaning the corners and recesses of the receiver.)
2. With a clean, dry, lint-free cloth, remove all cleaning solvent.
3. Using a patch or clean cloth, apply a light coat of gun lubricant to the outside surfaces of the barrel and receiver being careful to remove any excess lubricant.

#### CLEANING MUZZLE BRAKE

If your rifle is equipped with a removable (“screw-off”) muzzle brake, use the supplied wrench to unscrew the muzzle brake from the barrel. When viewing from the muzzle, turn the muzzle brake counter clockwise to unscrew.

1. With a bore cleaning brush of proper size attached to the cleaning rod, apply gun cleaning solvent to the brush.
2. Push the brush all the way through the muzzle brake several times. Repeat step 2 as many times as needed until all powder residue has been cleaned from the bore of the brake. Use of a plastic bristle gun cleaning brush will help to clean the threads and exterior of the muzzle brake.
3. Using a clean cloth, dry the solvent from the muzzle brake.
4. Insert a patch saturated with gun lubricant into the cleaning rod tip and push it through the muzzle brake. Remove the patch and withdraw the rod.
5. Insert a dry, clean patch into the cleaning rod tip and push it through the muzzle brake to remove excess lubricant. Remove the patch and withdraw the rod.
6. Using a patch or clean cloth, apply a light coat of gun lubricant to the outside surfaces of the muzzle brake, being careful to remove any excess lubricant.

#### CLEANING THE RECEIVER

1. Using a small lint-free cloth, clean the inside and outside of the receiver with gun-cleaning solvent and dry thoroughly with a clean cloth. Use of a plastic bristle gun cleaning brush will help to clean the recesses of the receiver.
2. Using a clean cloth, dry the solvent from the receiver.

3. With a clean cloth or patch, apply a light coat of gun lubricant to all accessible surfaces of the receiver, being careful to remove any excess lubricant.

#### CLEANING THE BOLT ASSEMBLY

Refer to Disassembly of the Bolt Assembly (*page 11*), Cleaning of the Bolt Assembly (*page 12*) and Assembly of Bolt after Cleaning (*page 12*).

#### CLEANING THE MAGAZINE

1. Using a lint-free cloth, clean the inside of the magazine, follower and spring with gun-cleaning solvent, and dry thoroughly with a clean cloth.
2. With a clean cloth or patch, apply a light coat of gun lubricant to inside surface of the magazine and to the follower and spring, being careful to remove any excess lubricant.

#### CLEANING THE TRIGGER GUARD ASSEMBLY

1. Using a small lint-free cloth, clean the outside of the trigger guard assembly; and with a clean tooth brush, brush the exposed surfaces of the trigger guard assembly with gun-cleaning solvent. Dry thoroughly with a clean cloth.

#### CLEANING THE TRIGGER ASSEMBLY

Using compressed air, blow the internal components of the trigger assembly off to remove any loose dirt and debris. No lubrication is required on the internal components of the trigger assembly. If oil seeps into the trigger housing, blow out the internals with compressed air again, and wipe off any excess oil residue.

Fig. 10

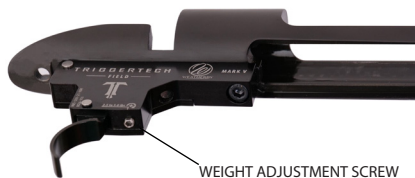

**Always wear eye protection when using compressed air to avoid injury to eyes by foreign objects.**

#### CLEANING THE STOCK

Usually, wiping the stock with a clean, dry cloth or a silicon cloth is all that is necessary. If you have been hunting or shooting in wet weather, allow the stock to dry thoroughly before storage.

NOTE: Do not use acetone or any abrasive solvent cleaners on carbon fiber stocks. This can jeopardize the external coating of the carbon fiber.

## RUST PREVENTION AND REPAIR

During normal maintenance, after a thorough cleaning, allow 2-3 hours at room temperature, for all metal parts to dry completely. Then apply a liberal amount of high grade Gun Oil to all metal parts, wiping off any excess with a clean dry cloth.

If rusting does occur it may only be surface rust due to excessive moisture. You may be able to clean it by using a plastic bristle gun cleaning brush and gun cleaning solvent. If you are unable to remove rust on your rifle, please contact a Weatherby Authorized Service Center or your local gunsmith. Immediate attention to this problem is imperative to prevent irreparable rust damage.

**DO NOT ALLOW RUST TO GO UNTREATED!**

---

# **ASSEMBLY OF WEATHERBY® MARK V® RIFLE**

---

## ASSEMBLY OF BARREL AND RECEIVER TO STOCK

1. With the barreled action resting upside down on a horizontal surface such as a workbench or table, place the stock onto the barreled action, aligning the recoil lug and trigger guard screw holes.
2. Insert the magazine box, seating it completely against the receiver.
3. Insert the trigger guard assembly with its follower and spring into the stock and hold in place.
4. Insert the trigger guard screws and lightly seat the screws, with a screw driver of proper size, while holding the rifle in a vertical position with the butt down. Pull down on the barrel to help seat the recoil lug on the receiver with the mating surface in the stock.
5. Tighten the trigger guard screws to the proper torque and in the proper sequence as follows. Always tighten the rear screw first to a torque of 35 inch pounds, followed by a torque of 35 inch pounds to the front screw. For wood and synthetic stocks this is the final torque value that should be used. On composite stocks with aluminum bedding blocks, apply additional torque to 55 inch pounds to the rear screw followed by 55 inch pounds to the front screw.

---

## **TRIGGER ASSEMBLY ADJUSTMENT**

---

The MARK V® Triggertech trigger assembly has a pull weight adjustment screw. The adjusting screw is located on the bottom of the trigger assembly and adjusts the weight of the trigger pull. The trigger is adjustable down to a weight of 2.5 lbs. If the screw is removed completely, the trigger will maintain a minimum pull weight of 2.5 lbs.



**⚠ WARNING**

**For safety reasons, it is recommended to operate your trigger at, or above, factory setting. Exercise caution when adjusting your pull weight and perform safety steps 1-7. For safety reasons, weight of trigger pull should not be adjusted below 2-1/2 pounds.**

The trigger assembly has been set at the factory for weight of trigger pull appropriate for most shooters. If you require a heavier or lighter weight of trigger pull, adjust as follows:

1. Unload the rifle (*refer to Unloading the Rifle, page 10*), remembering to **VISUALLY CHECK THE CHAMBER AND THE MAGAZINE TO BE CERTAIN THERE ARE NO CARTRIDGES IN THE RIFLE.**
2. To increase weight of the trigger pull, with a 5/64 Allen wrench turn the weight adjustment screw clockwise until desired weight of trigger pull is established. To decrease weight of trigger pull turn the weight adjustment screw counter-clockwise until desired weight of trigger pull is established (*refer to Fig.10*).
3. Before firing live ammunition after adjustment, perform the following tests:
  - 3A) Safety off: cycle action - firing pin should NOT move
  - 3B) Safety off: cycle action and pull trigger lever - firing pin should move
  - 3C) Safety off: cycle action and tap the butt-stock - firing pin should NOT move (NEVER PERFORM THIS STEP WITH LIVE AMMUNITION)
  - 3D) Safely repeat Steps 3A through 3F (NOT 3G) at a rifle range with live ammunition to ensure trigger adjustment was done correctly.

**⚠ WARNING**

**Do not service, modify, disassemble or tamper with your trigger. Contact Weatherby technical support for any questions or service required.**

## STORING YOUR RIFLE

Your Weatherby® Mark V® rifle may be stored fully assembled.

If storing your rifle fully assembled, release the pressure on the firing pin spring as follows:

1. Make certain the rifle is not loaded by following proper unloading procedures (*refer to Unloading the Rifle, Page 10*).

2. **Pointing the muzzle of the rifle in a safe direction**, while pulling the trigger slightly, close the bolt.

Do not store your rifle in a leather case, scabbard or foam lined gun case. Leather and foam can attract moisture and cause rusting.

For your safety, and the safety of others, store your rifle out of the reach of children either in a gun safe or with a lock or other safety device properly installed; and store your ammunition in a separate, locked location out of the reach of children.

---

## SUGGESTIONS FOR GETTING TOP PERFORMANCE FROM YOUR WEATHERBY® MARK V® RIFLE

---

1. **With the rifle unloaded**, check and tighten muzzle brake frequently -- before, during and after shooting. Muzzle brake threads may loosen with repeated recoil, which may result in changes in point of impact or damage to muzzle brakes or barrel threads with extended use.

2. Make sure that all trigger guard screws are properly tightened before firing the rifle. Always tighten the rear guard screw first and the front last (*refer to Assembly Of Weatherby® Mark V® Rifle, page 16 line 5*). Loose trigger guard screws not only contribute to inaccuracy but can also cause stock damage. Check these screws periodically as recoil and atmospheric conditions can cause them to work loose.

3. Be sure your scope or iron sights are secure. Loose mount screws are a definite source of inaccuracy. If you experience accuracy problems it is our recommendation that you contact your local gunsmith or an Authorized Weatherby® Service Center to check your scope.

4. The condition of the bore is important in obtaining optimum accuracy from you rifle. Be sure to follow the instructions for "Cleaning the Bore" on page 13.

5. The accuracy of any firearm can vary depending upon the brand and type of ammunition used in it. If your rifle does not exhibit the consistent point of impact you expect, you should try several brands and types of ammunition, after referring to point 1-3, above, before concluding that it is "inaccurate".

DO NOT ALTER THE STOCK BEDDING IN ANY WAY. Once a stock has been altered, it cannot be reworked by our Service Department.

6. Consult the factory before returning any product for inspection or repair.

# EXPLODED VIEW DIAGRAM

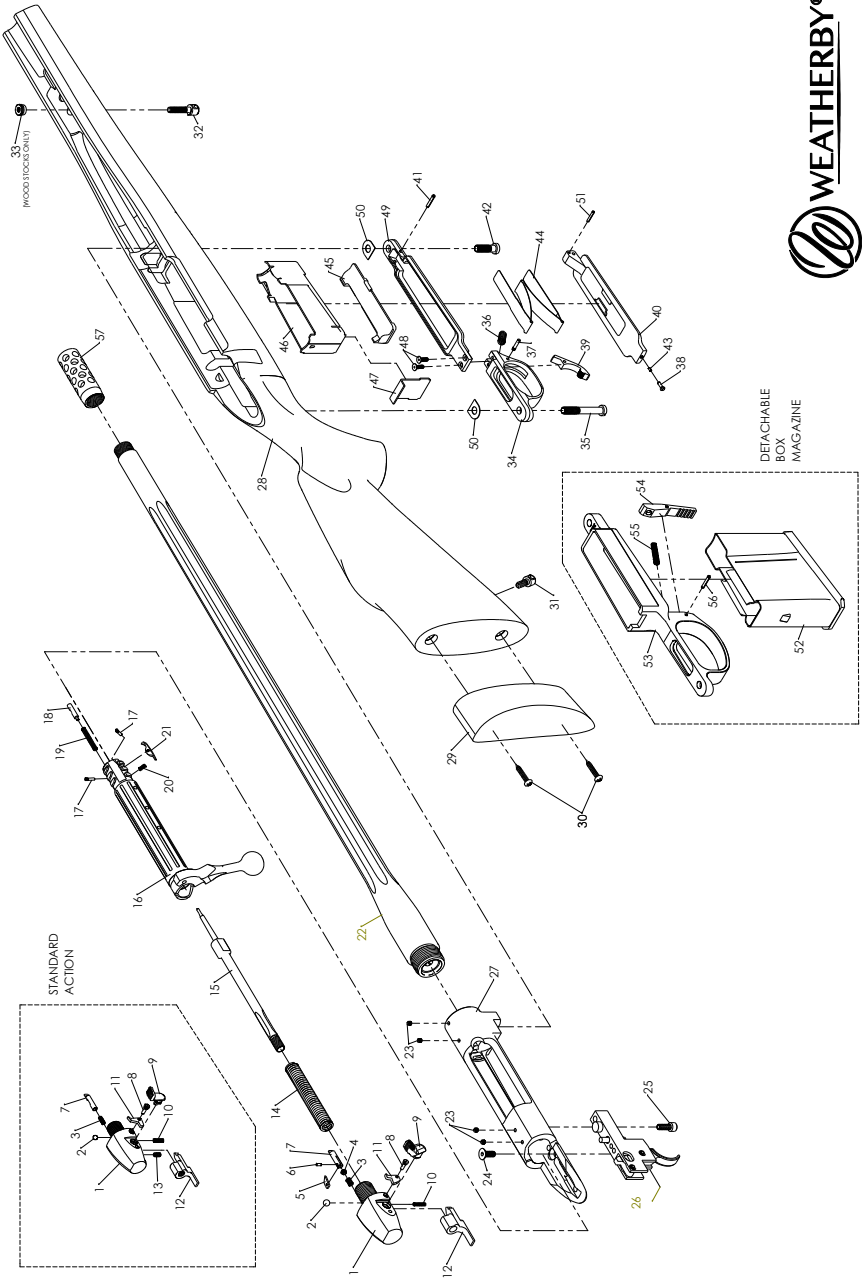

DEATCHABLE  
BOX  
MAGAZINE

# PARTS LIST

- 1) Bolt sleeve
- 2) Ball, retaining
- 3) Spring, plunger
- 4) Plunger, bolt sleeve lock
- 5) Retainer leaf, bolt sleeve lock
- 6) Pin, retainer leaf
- 7) Bolt sleeve lock
- 8) Screw, safety lever
- 9) Safety lever
- 10) Spring, safety hook
- 11) Safety hook
- 12) Cocking piece
- 13) Screw, bolt sleeve lock
- 14) Spring, firing pin
- 15) Firing pin
- 16) Bolt body
- 17) Pin, ejector
- 18) ejector
- 19) Spring, Ejector
- 20) Spring, Extractor
- 21) Extractor
- 22) Barrel
- 23) Screw, plug, receiver
- 24) Screw, top trigger housing
- 25) Screw, bottom trigger housing
- 26) Trigger
- 27) Receiver
- 28) Stock
- 29) Recoil pad
- 30) Screw, recoil pad
- 31) Swivel stud, rear
- 32) Swivel stud, front
- 33) Nut, swivel stud front
- 24) Trigger guard
- 35) Screw, trigger guard rear
- 36) Spring, floorplate catch
- 37) Pin, floorplate catch
- 38) Post, floorplate
- 39) Latch, floorplate
- 40) Floorplate
- 41) Pin, floorplate
- 42) Screw, trigger guard front
- 43) Spring, post
- 44) Spring, follower
- 45) Follower
- 46) Magazine box
- 47) Insert, magazine box
- 48) Screw, trigger guard assembly
- 49) Pivot frame, trigger guard
- 50) Shim
- 51) Pin, floorplate stop
- 52) Detachable box mag
- 53) Bottom metal DBM
- 54) Release Lever
- 55) lever retaining Pin
- 56) Lever swivel Pin
- 57) Muzzle Brake

---

# WEATHERBY® SERVICE POLICY

---

Weatherby® is a name that has been synonymous with quality firearms for over 70 years. All Weatherby® firearms are manufactured of the finest materials and have been thoroughly inspected and tested in every phase of production. Because of the confidence we have in our products, Weatherby, Inc. does not provide a written warranty, but rather stands behind its reputation for customer service and satisfaction.

Simply stated, we will consider requests for service or repair of Weatherby® firearms without charge on a case by case basis. A determination will be made taking into consideration such things as the age and condition of the firearm, and the circumstances surrounding its malfunction or other problem.

Weatherby, Inc. will not be responsible for defects resulting from ordinary wear and tear, alterations by unauthorized persons, accidents, misuse, use of incorrect or other than factory loaded ammunition, or failure to provide reasonable and normal maintenance.

Should any Weatherby® firearm require service or repair under this service policy, it must be delivered transportation prepaid to a Weatherby Authorized Service Center (names and addresses supplied by Weatherby upon request). The product must be accompanied by a proof of purchase and a letter explaining the problem. It should also be insured by the owner at the time of shipment, as Weatherby, Inc. can accept no responsibility for damage or loss in transit. Weatherby will pay all charges to return the product to the owner if it is accepted for service or repair without charge under the provisions of this service policy. Weatherby, Inc. also reserves the right to repair or replace any product at our sole discretion.

**WEATHERBY, INC. SHALL NOT BE LIABLE FOR ANY CONSEQUENTIAL, INCIDENTAL OR CONTINGENT DAMAGES.**

---

## TEN COMMANDMENTS OF FIREARMS SAFETY

---

All hunting and shooting accidents can be prevented if people understand and follow basic firearms safety rules. Responsible, knowledgeable, and safe hunters and shooters will learn, remember and follow these simple rules:

1. Treat every firearm as if it is loaded – it may be!
2. Control the direction of your firearm's muzzle. Carry your firearm safely, keeping the safety on until ready to shoot. Keep your finger off the trigger until ready to shoot.
3. Identify your target and what is beyond it. Know the identifying features of the game you hunt or the targets you intend to shoot.

4. Be sure the barrel is clear of any obstruction before loading. Make it a habit to check the barrel every time before reloading. Use only ammunition of proper caliber or gauge for the firearm you are going to shoot.
5. Whenever not in use, keep your firearm unloaded and store all ammunition in a separate location.
6. Never point a firearm at anything you do not want to shoot. Avoid all horseplay with a firearm.
7. Never climb a fence or tree, or jump a ditch or log, with a loaded firearm. Never pull a firearm toward you by the muzzle.
8. Never shoot at a flat hard surface or water. During target practice, be sure your backstop or shot-fall area is adequate.
9. Store firearms and ammunition separately beyond the reach of children and careless adults.
10. Avoid alcoholic beverages or other drugs before or while shooting.

---

## **EXERCISE EXTREME CAUTION WHILE HANDLING ANY FIREARM**

---

### **Heed and follow these additional gun handling warnings whenever using any firearm**

- Be sure the barrel is clear of any obstruction before loading. Make it a habit to check the barrel every time before reloading.
- Never place a loaded gun into a vehicle or lean the gun against any object. The gun should be emptied and placed into a case when not in use.
- Keep the safety on at all times. Move the safety to the "FIRE" position only when you are sure that a shot is imminent.
- While loading or unloading, make sure the gun is pointed in a safe direction. Keep your finger off the trigger while operating the action.
- If your firearm fails to fire when the trigger is pulled, HANDLE WITH CARE!
- If you do not thoroughly understand the proper use and care of your gun, seek the advice of someone you know is competent.
- Do not abuse your hunting privileges. Be respectful of others and other people's property.

Weatherby®

**MARK V® RIFLE  
OWNER'S MANUAL**

REVISED & PRINTED January 2020

Weatherby, Inc.  
1550 Yellowtail Dr  
Sheridan, WY 82801

WEATHERBY® and MARK V® are registered trademarks of Weatherby, Inc.



## WARNING

Firearms must be handled responsibly and securely stored to prevent access by children and other unauthorized users. California has strict laws pertaining to firearms, and you may be fined or imprisoned if you fail to comply with them. Visit the web site of the California Attorney General at <https://oag.ca.gov/firearms> for information on firearm laws applicable to you and how you can comply.

Prevent child access by always keeping guns locked away and unloaded when not in use. If you keep a loaded firearm where a child obtains and improperly uses it, you may be fined or sent to prison.



## ADVERTENCIA

Armas de juego deben de ser usadas responsablemente y almacenadas en un lugar seguro para proibir el acceso a menores de edad y personas no autorizadas. California tiene leyes estrictas sobre la posesión de armas de juego y usted puede ser multado o encarcelado si no las cumple. Visite la pagina de internet de California Attorney General en <https://oag.ca.gov/firearms> para obtener información de las leyes de armas de juego que aplique a su caso y como puede cumplirlas.

Mantenga armas de juego lejos de menores de edad, manteniendo las armas descargadas y encerradas en un lugar seguro cuando no esten en uso. Si mantiene una arma de juego cardaga donde un niño tenga acceso y la utiliza incorrectamente, usted puede ser multado o encarcelado.

**REVISED & PRINTED September 2019**

**Weatherby, Inc.**

**1550 Yellowtail Dr • Sheridan WY 82801 • (307) 675-7800**

**[www.weatherby.com](http://www.weatherby.com)**